

# R-4990 HEAVY DUTY TRENCH

Materials: All frames and grates/lids are furnished standard in gray iron, meeting ASTM-A48 Class 35-B for heavy-duty use. For extra heavy-duty use or superior durability requirements, see our ductile iron Airport and Port Grating Series on page 286.

Neenah recommends project designers avoid the use of light duty trench installations because it is likely that applications will be subjected to heavy delivery vehicle traffic at some time. Furthermore, the use of a site could be changed to heavy duty use patterns at some unanticipated future date.

Dimensions in inches

Un-Bolted Catalog No.	A	B	C	Type A	Type C	Type D	Type E	Type P	Type Q
R-4990-AX	8	1 1/2	6	x	x	x	x	x	
R-4990-BX	10	1 1/2	8	x	x	x	x	x	
R-4990-CX	12	1 1/2	10	x	x	x	x	x	x
R-4990-DX	14	1 1/2	12	x	x	x	x	x	x
R-4990-EX	17	1 1/2	15	x	x	x	x	x	
R-4990-FX	20	1 1/2	18	x	x	x	x	x	
R-4990-GX	23	1 1/2	21	x	x*	x			
R-4990-HX	26	1 1/2	24	x	x*	x	x		x
R-4990-JX	30	2	27	x	x	x			
R-4990-KX	33	2	30	x	x	x*	x		
R-4990-LX	36	2	33	x	x	x*			
R-4990-MX	39	2	36	x	x*	x			
R-4990-NX	45	2	42	x	x*	x			
R-4990-OX	51	2	48	x		x*			

x - Indicates availability.

\* Deep Ribs (consult shop drawing for dimensions).

Deep Ribs = "B" dimension times 2 or greater.

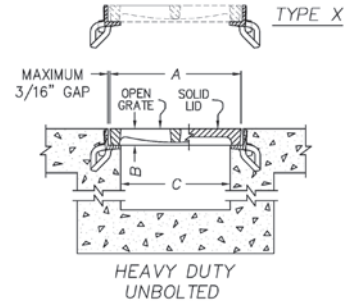

General schematic shown may not apply to all designs. Bar and rib depths, plate thicknesses and seating widths vary on different sizes and styles. If your project has design restrictions, contact your sales representative or product engineering.

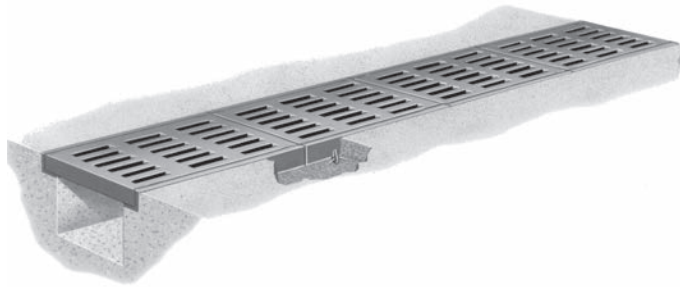

Illustrating Type C trench. Trench sections are furnished in 24" standard lengths.

Note: In Type A and P grates the slots are perpendicular to the trench run. In Type C and Q grates the slots are parallel with the trench run.

## Read Carefully Before Ordering

The various standard trench drains are available with a number of alternatives. It is important to examine all of the variables carefully and specify your requirements fully. Your order will be entered correctly and promptly if it includes the following information:

- Complete catalog number
- Frame end pieces, when required
- Type of Lid or Grate: A, C, D, E, P or Q
- Length of trench sections
- Angles and intersections \*
- Load requirements

\*Trenches with angles, intersections, size changes or other special requirements require detail drawings prior to ordering. Contact your sales representative or product engineering for assistance.

800-558-5075

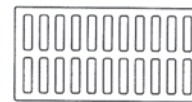

TYPE A  
GRATE OPENINGS

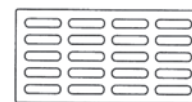

TYPE C  
GRATE OPENINGS

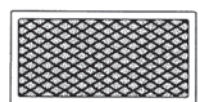

TYPE D  
SOLID LID

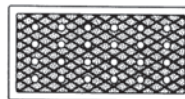

TYPE E  
VENTED LID

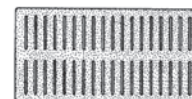

TYPE P  
GRATE OPENINGS

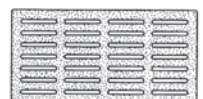

TYPE Q  
GRATE OPENINGS

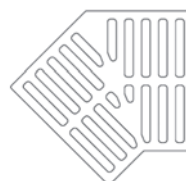

TYPE A  
45 DEGREE  
INTERSECTION PC.

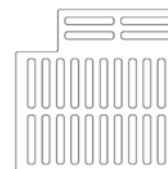

TYPE A  
90 DEGREE  
INTERSECTION PC.

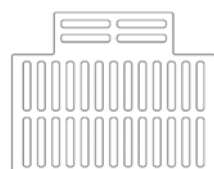

TYPE A  
"T" INTERSECTION PC.

Note: 45°, 90° and "T" available in limited sizes and types.